

Opel 1900cc Engines: Tuning & Vacuum Notes

Opel engines require proper fuel, compression, correct ignition timing & spark. Tuning to correct specifications, will maximize your power output.

IGNITION

Verify voltage is present at the "+" terminal in the ignition coil, and check for a spark at each plug (when cranking). Mis-fires can be difficult to diagnose (particularly when they occur intermittently), so always start with all new parts.

Important Specifications

- Distributor: Set at zero degrees TDC (with vacuum lines plugged), at low idle
Avoid excessive advance (detonation damages pistons & rings)
Check "indentation shape" on cap edge (to identify style)
- Point Gap: Set at .018" & verify 50 degree (+/- 2°) "dwell" measurement
- Spark Plug Gap: Set at .030"
- Firing Order: 1-3-4-2
(clockwise)

Point set & Condenser can be replaced w/electronic ignition #6165 for better driveability!



Recommended
Replace all maintenance items with new parts
Distributor Cap & Rotor #6041
Ignition Point Set #6042
Condenser #6043 (or Module #6165)
Spark Plugs #6040, 6163, 6175
Ignition Wire Set #6071

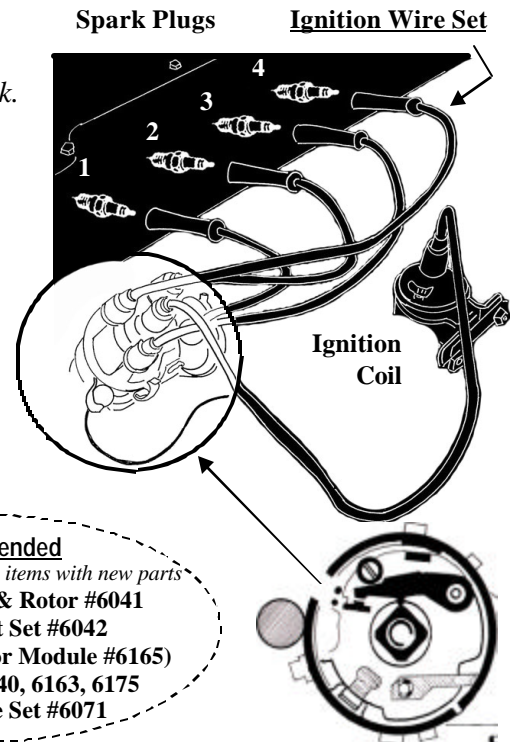

Camshaft Timing

"Dowel Pin" on camshaft sprocket is at "6 o'clock" (and "ball mark" on outer edge of gear needs to align to "notch" in curved metal support plate, when measured through center of the cam gear).

"Ball" along outer edge of cam gear (aligns to notch through center)

#1 TDC

"Dowel" mark

"Notch" in plate

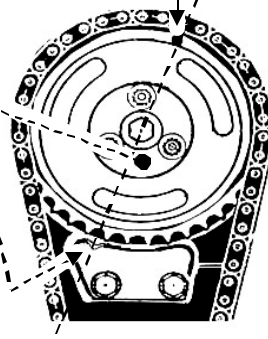

"Ball" on flywheel aligns to pointer

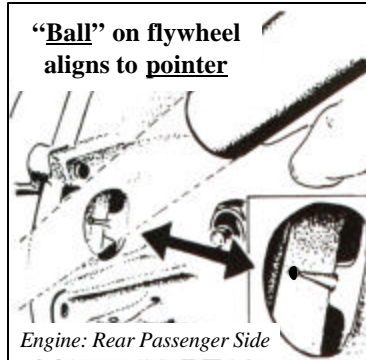

Engine: Rear Passenger Side

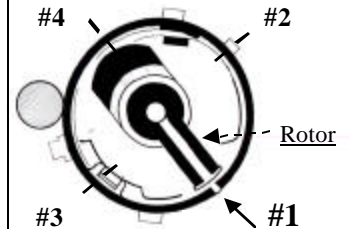

Rotor points to #1 TDC Mark, located on outer edge of distributor housing

Notes: The engine can be rotated clockwise, using a wrench to turn the 19mm crankshaft pulley bolt.

Fuel pump must be removed from timing cover (before distributor can be removed or installed)

Setting Engine & Distributor Timing Marks

COMPRESSION

Standard maintenance includes measurement of engine compression (at each cylinder), and verification of proper valve adjustment and camshaft timing.

Important Specifications

- Compression: "Acceptable" range is 134psi to 180psi
(Measure "dry" with charged battery & open carb throttle plates)
- First verify that you have either hydraulic or solid-type lifters (hydraulic lifters have a separate "cap" and hole in the side)
- Valve Adjustment Specifications: Hydraulic Lifters: Zero Gap, plus 3/4 turn (270 degrees) in
Solid Lifters: Set at .012" at TDC HOT for both intake & exhaust (Note: Solid lifter gap can vary, on some performance camshafts)
- Cam Dowel Pin: Ensure timing marks are aligned correctly.
("6 O'clock" for TDC #1, "12 O'clock" for TDC #4)

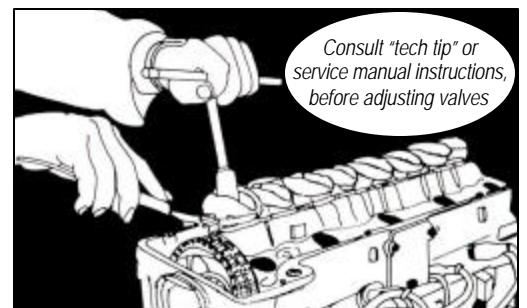

Consult "tech tip" or service manual instructions, before adjusting valves

Use 15mm deep-socket on rocker nuts (at TDC of each cylinder) to adjust valves

If adjusted on idling engine, install curved "oil deflector" plate above timing gear



Engine Tuning: Ignition/Tune Up

A dependable spark is necessary to achieve drivability (from a 4-cylinder Opel engine). We suggest frequently checking the ignition point gap (using a dwell meter reading), or upgrading to an electronic ignition kit, for maximum reliability, optimum fuel efficiency, and top performance.

Ignition Parts

- 6040 Spark Plugs, Champion (Specify type, 4 req. per engine)
- 6163 NGK Spark Plugs (Higher-Performance), Set of 4
- 6175 Denso Iridium Spark Plugs (Long Life)
- 6041 Distributor Cap and Rotor, Specify Year & Type:
(See images below, to identify a replacement style you need)
- 6078 Distributor Cap, Colored, 1970-1975 Engine
- 6042 Ignition Contact Points (1968-1974)
- 6134 Contact Points, 1975 type Bosch fuel injection systems
- 6043 Condensor 1970-1975 distributors
(specify round or square-hole mount, as seen inside distributor)
- 6043 Condensor, 1968-1969 distributors
- 6071 Ignition Wire Set, Bosch 7mm silicon, pre cut.
- 6165 Pertronics Electronic Ignition. spark control module.
From original manufacturer, Eliminates points forever!
Includes Opel-specific installation instructions.
- 6166 Flame Thrower Ignition Coil (Pertronix), 40,000 volts
- 6122 Allison/Crane (Optical Points) Electronic Ignition Kit

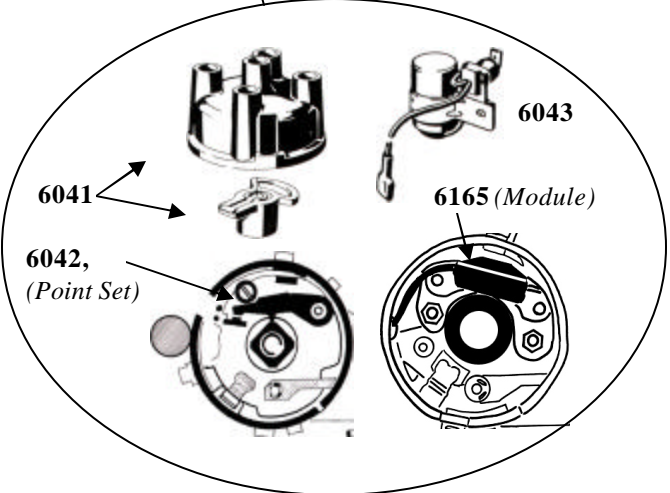
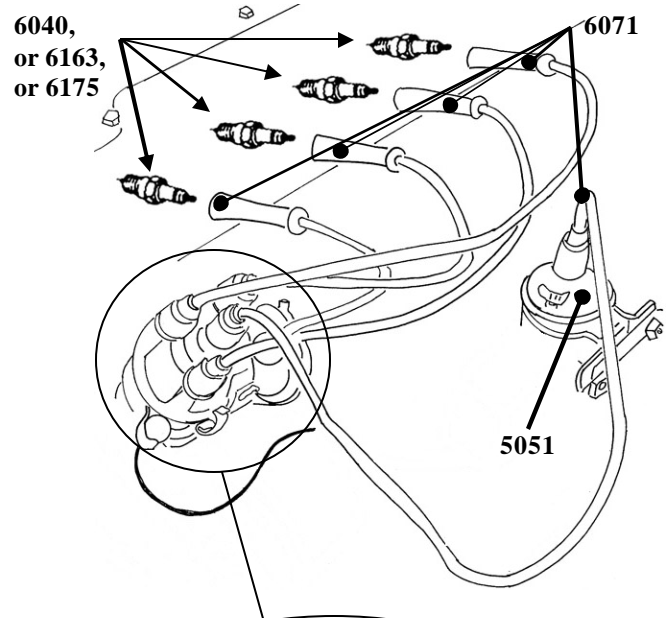

Other (Recommended) Tune-Up Related Parts

- 9024 Original (Round) Air Filter (Check canister style for fit)
- 9003 Weber 32/36 Air Filter Kit
- 9042 Aftermarket (Plastic) Fuel Filter
- 11013 Fan Belt (specify alternator mount style for correct length)

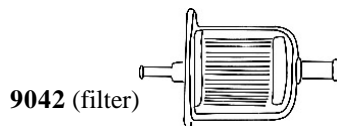
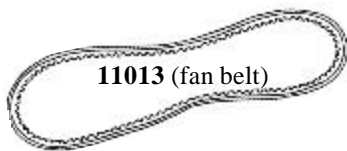

Distributor Cap Style Variations

Ordering the correct matching replacement distributor cap requires identification of the style you currently have.

Be aware that there are 2 styles of Opel distributor caps: an early style and a later style.



Opel 1.9 Engine Tune-Up Specifications

- Spark Plug Gap: .030" Ignition Point Gap: .018" or 50 degrees dwell (+/- 2 degrees on a dwell meter)
- Spark Plug Firing Order (Clockwise) 1-3-4-2 (#1 Spark Plug, is at engine block front, closest to radiator)
- Timing: Set at Zero degrees TDC (with vacuum lines removed from distributor and hoses plugged).
(Timing also requires correct alignment of engine timing marks. Also verify there are no vacuum leaks)
- Engine Compression: Factory minimum listed as 134psi; Engines run best from 136 to 180psi.



Opel Engines: Tune Up Basics

FUEL

Opel owners who want reliable operation are advised to install a trade-marked Weber 32/36 carburetor, and to use "fresh" fuel (less than 6 months old).

Important Notes

Correct installation procedures are important for proper carburetor function. (This includes use of a "thick" style gasket coated with Permatex "high tack" sealer).

Tighten associated mounting bolts and nuts (use of a "short" 13mm wrench on carb mount nuts & a 15mm "obstruction" wrench on manifold bolts is suggested).

To adjust idle mixture: We suggest turning mixture screw all the way in, then backing it out 2 full 360-degree turns, then fine tuning it in or out when car is warm and at low idle. Readjust idle speed to factory specification (we prefer about 950-1000 rpms for street use).

Replace air filter and consider adding a fuel pressure regulator (if pressure exceeds 3.5 psi).

Some high-performance engines require a faster idle speed & larger internal jets.

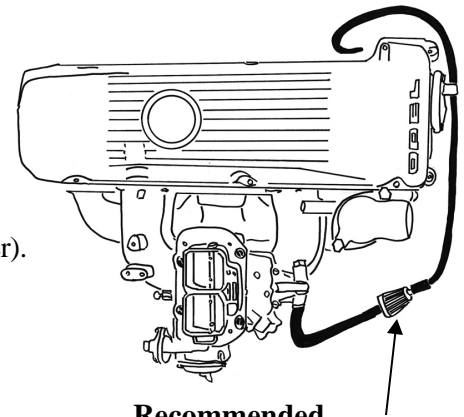

Recommended

Install clear "see-through" type filter in-line to carburetor (to verify fuel flow)

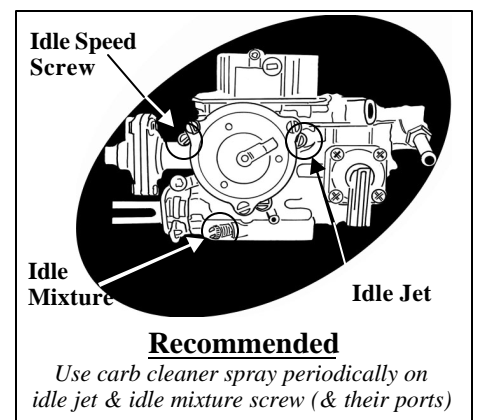
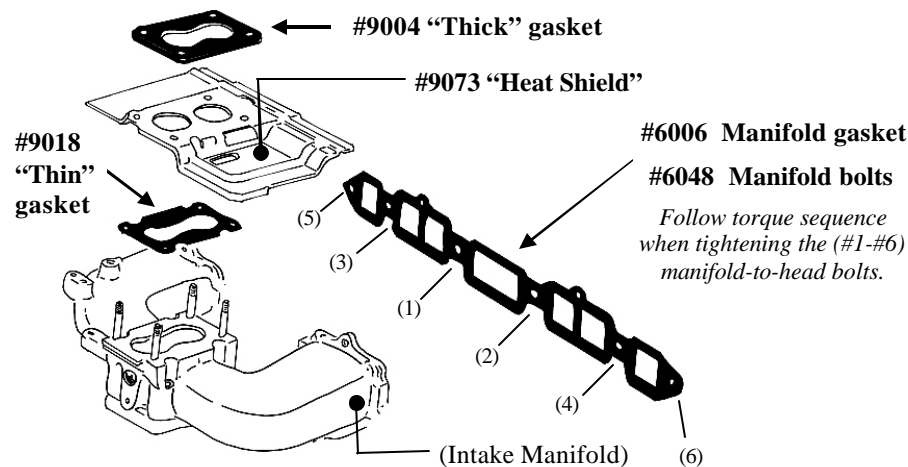

Recommended

Use carb cleaner spray periodically on idle jet & idle mixture screw (& their ports)

VACUUM

Opels are particularly sensitive to vacuum leaks, which also have an adverse affect on ignition timing, power brakes (& shifting of the auto trans, if installed).

Common symptoms of a vacuum leak include an inability to idle below 1000rpms, and a "stumble and surge" response during acceleration. This also reduces your fuel economy and can cause engine damage. A test procedure, is described below.

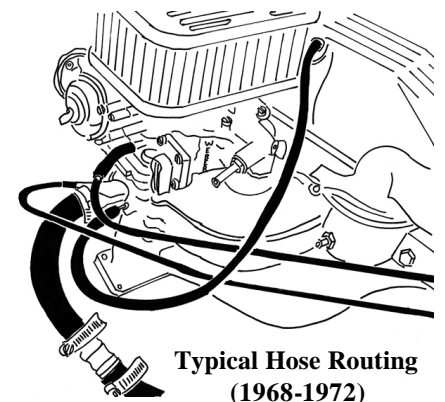

An important test is for vacuum leaks. Run the engine at a warm idle, then spray carburetor cleaner at all gasket, hose and hardware junctions to the intake manifold. If idle speed suddenly changes at a place, you have a vacuum leak there.

Replace parts where vacuum leaks are found

Recommendations

Replace all maintenance items with new parts, and:

Reseal threads of booster "tree fitting" with Teflon tape

Replace ends of vacuum hoses, with new rubber sections

Test distributor & brake booster diaphragms for leakage

Check operation of one-way "check valve" to booster

Check condition of o-rings on carburetor idle jets

Verify grommets installed on throttle linkage #9005, #9006

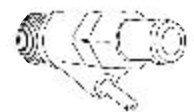

"Tree" fitting



Engine Tuning: Vacuum System

Vacuum controls engine timing (through the distributor), correct fuel system tuning (through the carburetor), braking (through the booster) and accessories like an automatic transmission or air-conditioning (when installed).

Sealing engine-related vacuum leaks isn't just a performance option; It's a critical requirement for all Classic Opels.

Symptoms are common but often unrecognized: A "stumble and surge" upon acceleration, difficulty adjusting the idle mixture on the carburetor, and overall poor performance (combined with poor gas mileage).

Test procedures (described on adjacent page) can help identify areas of common leaks.

The best solution is to replace all the seals and gaskets that help retain vacuum when you first acquire your Opel. (Also check all related parts, like hoses and hardware, to assure they are installed correctly and are sealing properly)

This is especially important on Opels that haven't been properly maintained (or were parked) for some time, and by "new" (first-time) Opel owners. A pro-active approach to sealing vacuum enables engine tuning with confidence (without having to "hunt" for specific leaks) and finished results save gas while increasing engine performance.

Opel GT Source recommends replacing vacuum system-related maintenance parts

- 4019 Brake Booster Hose Inlet Seal
Rotate the plastic elbow 90 degrees counter-clockwise to access this seal Fits original-style boosters.
- 4030 Brake Booster to Master Cylinder Seal
Wear on this master cylinder "front seal" causes leaks
- 4041 Brake Booster Hose
Vacuum pressure present within the brake booster circuit requires this "thick" reinforced replacement hose.
- 4053 Brake Booster One-Way "Check" Valve
Located on the booster hose about 9" from the manifold port, this valve helps maintain vacuum to the (original-style) booster
- 6006 Intake/Exhaust Manifold Gasket
Loose bolts often cause vacuum leaks at this junction
- 6048 Intake/Exhaust Manifold Bolts (to cylinder head, 6 required per car)
Bolt threads (9mm) are subject to wear from vibration; Replace if worn.
- 9004 Thick Carburetor Mount Gasket
A special 3/16" **thick** gasket, to seal vacuum at a critical junction & insulate the carburetor from damaging manifold heat. Helps to reduce vapor-lock in warm weather driving. Do **NOT** use a thin gasket here !! Use with #12017 sealer (listed below).
- 9018 Thin Carburetor Heat Shield Gasket (if heat shield is installed)
- 9034/W Intake Studs (Specify 9034W for Weber carb or 9034S Solex; 4x per car)
- 12017C Gasket Sealer ("High Tack" 4 oz can, offered as convenience item)

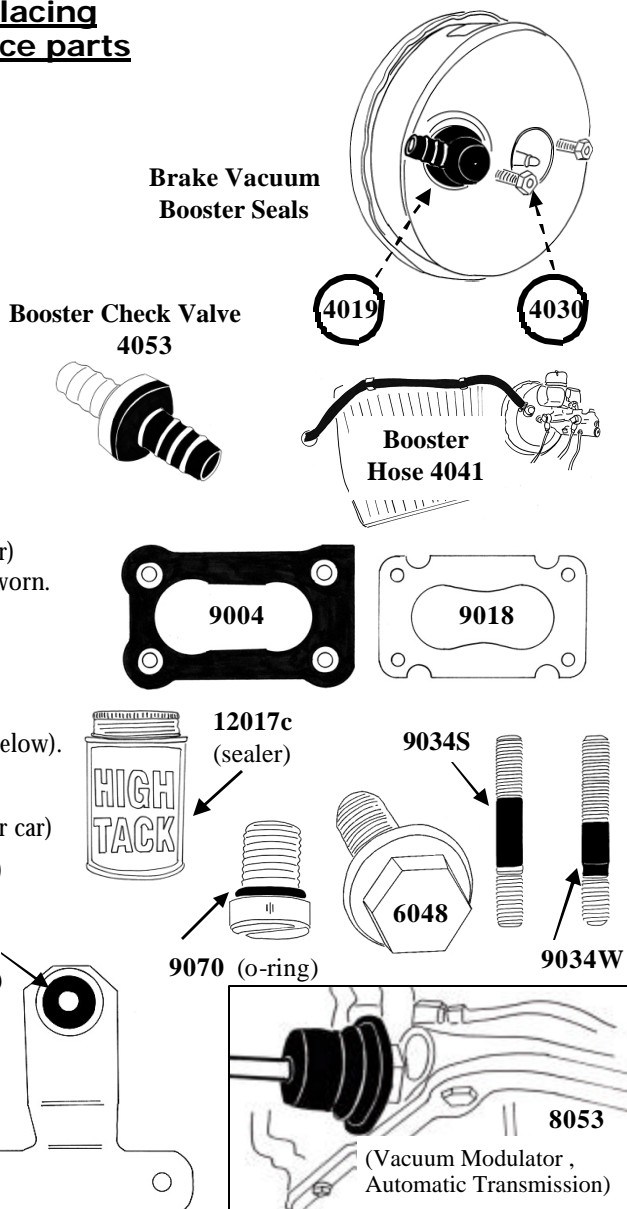

Additional Vacuum-Related Hardware

- 9005 Throttle Grommet, Passenger Side linkage
This helps reduce wear on the critical "throttle shaft bushing" of the carburetor
- 9006 Throttle Grommet, Driver's Side linkage
This assists pivoting of the driver's side linkage during acceleration
- 9070 Idle Jet O-Ring (for Weber carb, specify diameter size)
An often neglected source of a "hidden" vacuum leak.

Manifold Bolt Notes

Opel owners have become aware over the years of important issues related to the mounting of their manifold assemblies.

Heat-cycling and corrosion has affected threads on most original bolts, and when they can no longer hold properly, critical vacuum leaks commonly develop.

Factory bolts became harder to find, and some replacements did not include the important thick washer (needed to properly secure the manifolds in place with typical crush-style gaskets).

In response, Opel GT Source produced a special line of new bolts, featuring a choice of an original 15mm hex-head or an 8mm allen-head. These exclusive designs include a floating washer of the same thickness and diameter of the original, for an optimal fit. *Installation tips follow here.*

Removal of Original Manifold

You can use an ordinary socket wrench, combined with use of a 15mm “obstruction wrench” in tight areas, to remove the existing six (6) bolts that hold the manifold assembly to the side of the cylinder head.

If you intend to separate the original intake manifold from the combined assembly, pre-lubricate bolts with a penetrating spray (WD40, Liquid Wrench, PB Blaster, Kroil, etc), and turn the bolt heads with a special 8mm Serrated Bit tool, being cautious not to strip them. *See our “header notes” also if applicable.*

Preparing Surfaces and Bolt Holes

Test each of the 6 bolt holes in the side of the cylinder head, by first threading a new bolt into it. For best results (and most accurate torquing), clean out each hole with a 9mm x 1.25 “thread chaser” type tap.

Verify even fitment of the manifold faces where they will contact the cylinder head, and also verify there is a comparable thickness where attaching bolts will hold intake and exhaust manifolds to the head (if necessary consider adding a shim manufactured from a thin washer).

Use a sharp blade or gasket scraper on mating surfaces of the manifold assembly and cylinder head, to make sure they are flat and clean.

Loosely mount the gasket on the side of the head (using 2 dowel pins), then line up the manifolds on those pins for re-assembly.

Reinstall bolts carefully, starting with the 2 center bolts, by finger-threading them counter-clockwise until the first thread is seated, then turning them in clockwise (also by hand).

It is normal for bolts to feel loose here, until they are fully torqued. (“Anti-seize” may be used here to lubricate the threads if desired).

The factory torque specification is 33 foot pounds, and the proper tightening sequence is to start with the two inside bolts, then work outward in a cross-wise fashion. *See “header notes” also if applicable*

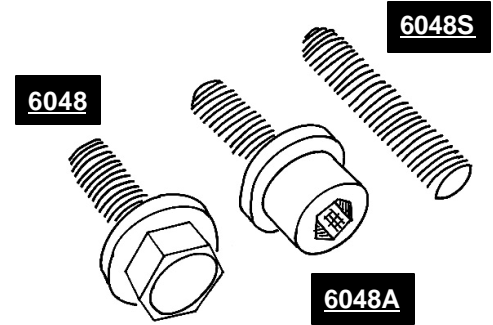

Manifold Hardware Lineup

Original Style Bolt #6048
Allen Head Style Bolt #6048A
Special Mount Stud Kit #6048S

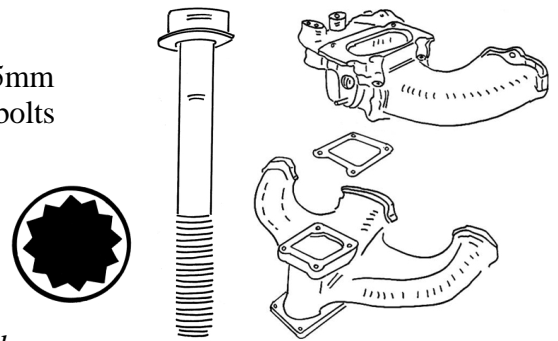

Use proper tools and procedures if manifolds are to be separated

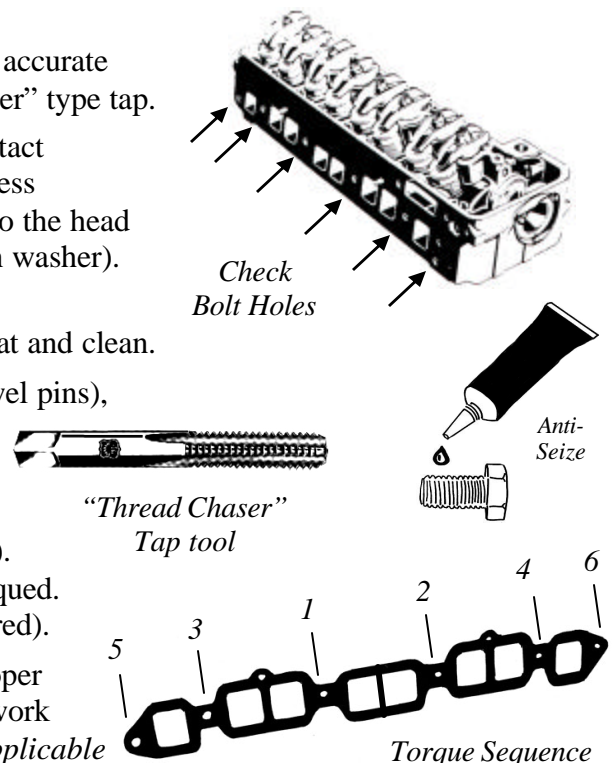

Vacuum System: Where Do the Hoses Go?

One of the most frequent questions we receive from new Opel owners, is "Where Do the Hoses Go"?

This topic has been revisited by OMC over the years, but the question still gets asked, and in some cases the answers weren't entirely understood.

To hopefully settle this matter for good, this is the first comprehensive hose-by-hose breakdown compiled anywhere (that we know of).

Because most Opels are operating with Weber carburetors, that's what this is based on. (Some Solex-only hose configurations are on a Solex info page).

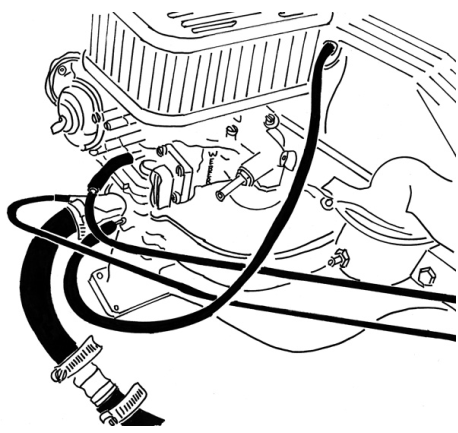

Distributor Vacuum Advance Hose

This hose connects a port on the passenger side of the carb (facing the passenger side fender), to an advance port on the distributor. The side port is in approximately the same position on the common Opel carburetors: Solex 32DIDTA & Weber 32/36 DGEV. This is the larger of the two hoses that are on most Opel 1.9 engines (Original 1975 distributors do not have a timing advance).

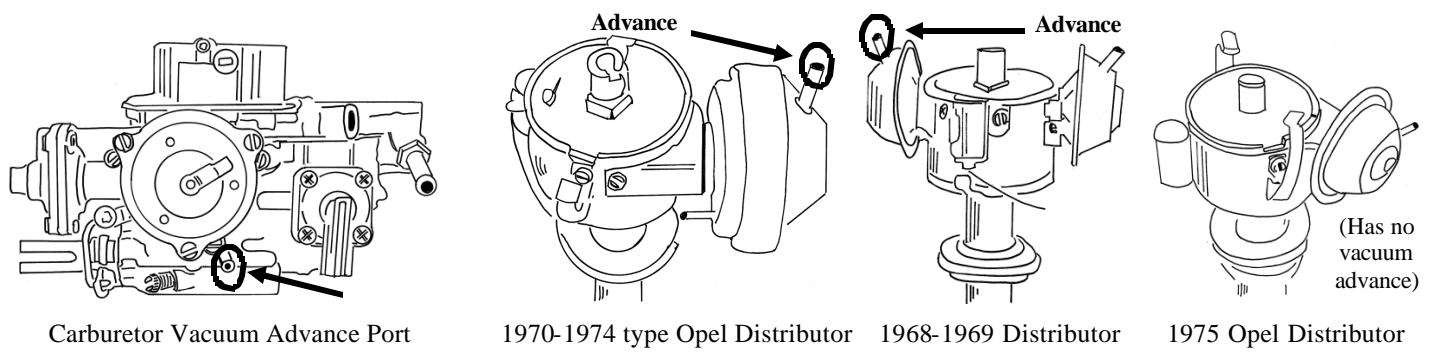

Distributor Vacuum Retard Hose

This hose connects a port from the "booster tree" fitting on the side of the manifold, to the retard port on the distributor. The manifold port is either on the lower side of the manifold (facing the passenger fender) on 1968-1972 Opels, or on the side (facing the engine) on 1973-1974 Opels. This is the thinner of the two hoses to the distributor that are on most Opel 1.9 engines.

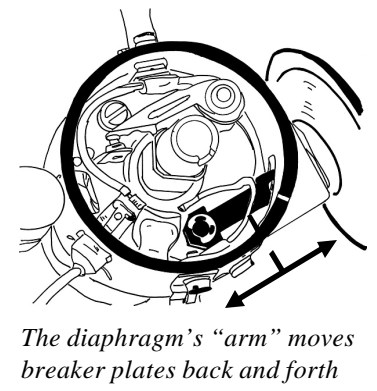
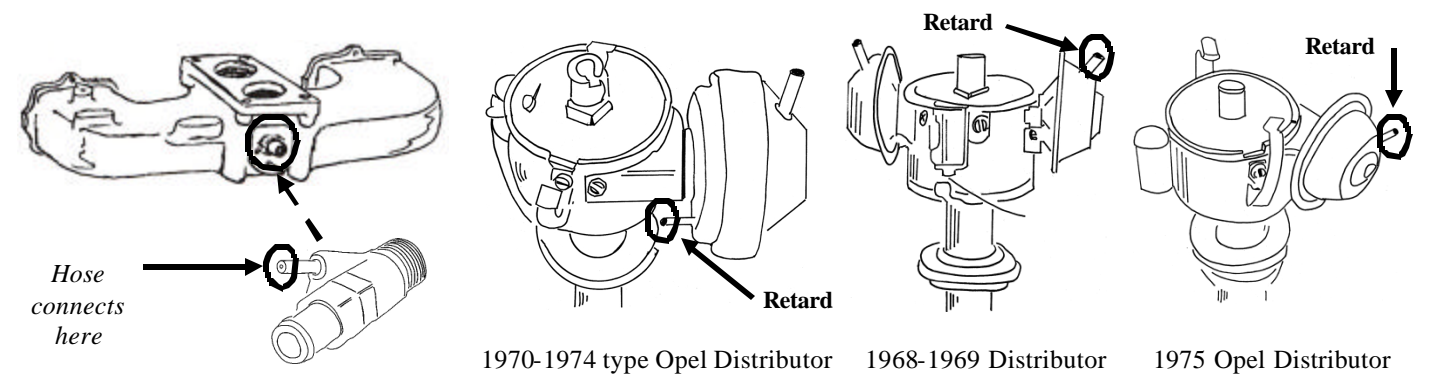

The diaphragm's "arm" moves breaker plates back and forth

Distributor Vacuum Diaphragm Evaluation

After years of operation, the vacuum diaphragm in the distributor can develop a hard-to-identify vacuum leak.

You can do a quick test by sucking on one end of the advance hose and observing the breaker plates in the distributor (they should move slightly).

Verifying that the diaphragm will hold vacuum completely, requires a leak-down test with a hand held air pump (of the type shown at right).

If leaking, replace with a newly-rebuilt distributor.

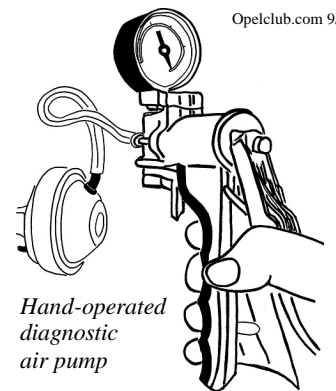

Hand-operated diagnostic air pump

Brake Vacuum Booster Hose

This wide hose connects the large screw-in port on the side of the manifold, to the plastic fitting on the vacuum brake booster. It is important to have a working "one-way valve" installed in this hose, about 8 to 10 inches from the manifold fitting. It's also important that the threads of the manifold fitting be vacuum-tight (seal these with Teflon tape) and that the plastic right-angle fitting to the booster itself also be vacuum-tight (check the condition of its rubber seal, and replace it if dry or worn).

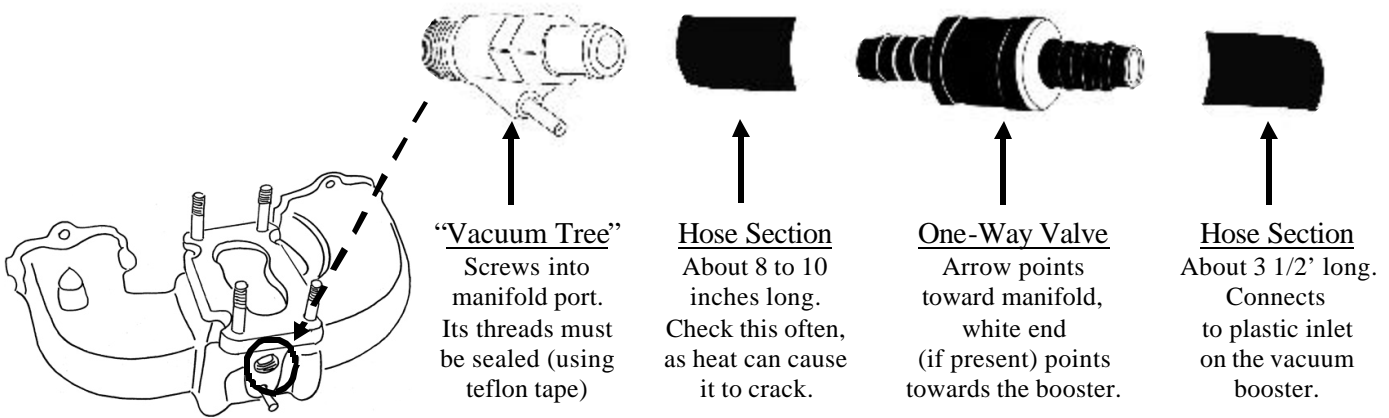

Hose Routing

Only replace with reinforced hose, made for this specific power brake vacuum application. (Do not use inferior hoses, like water or fuel hose, as they collapse under vacuum pressure)

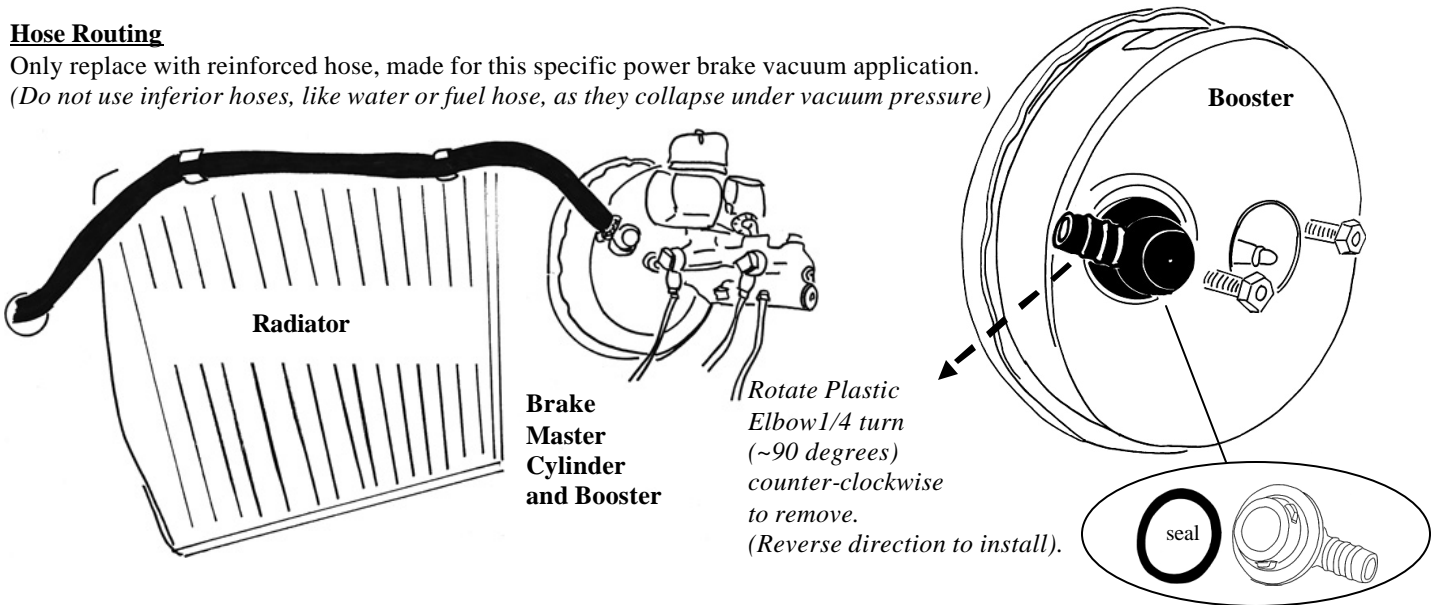

Automatic Transmission Vacuum Hose

Opelclub.com 9/2009

The operation of the vacuum modulator circuit is important to the shifting of an automatic transmission Opel. The vacuum line must be securely connected at the vacuum port on the intake manifold and to the modulator on the automatic transmission, and the modulator must be functional, or the transmission won't be able to shift itself out of first gear. It's also important for all other vacuum-related hardware (like other hoses and gaskets) to be leak-free as well.

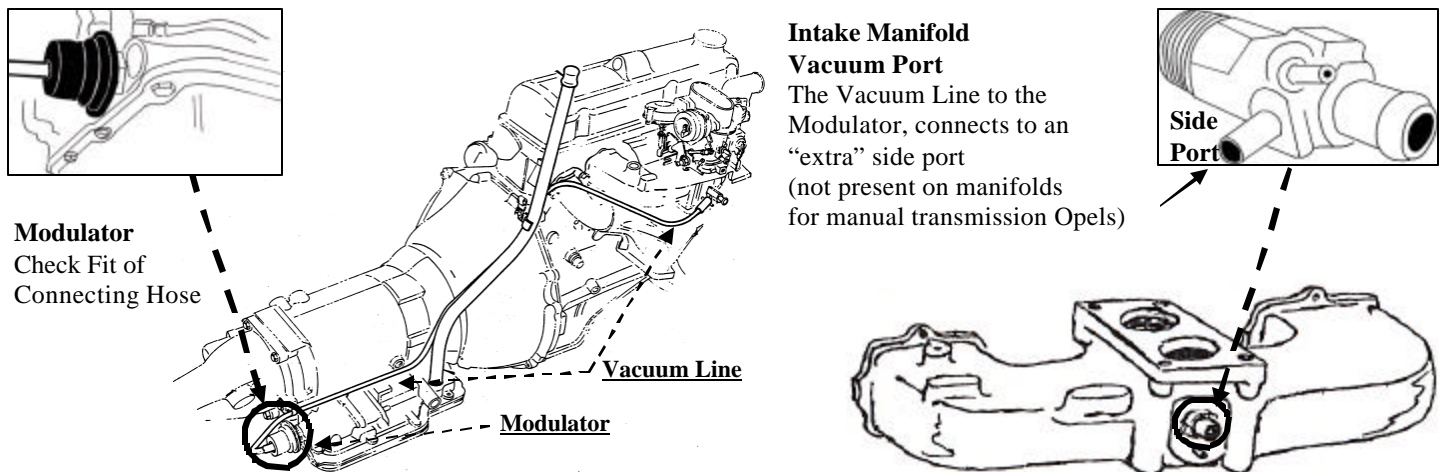

Valve Cover Hoses

These hoses are simply pressed in to the ports on the valve cover.

Proper connection of these hoses allows the engine to “breathe” and reduces oil seepage (which, when these ports are blocked, tends to occur at the gaskets).

Although this is called “Positive Crankcase Ventilation,” there is **NO** PCV valve installed or used. (Opel used a “metered orifice”). (To enhance PCV “breathing” you can also clean out the mesh screens, located under metal plates within the underside of the cover).

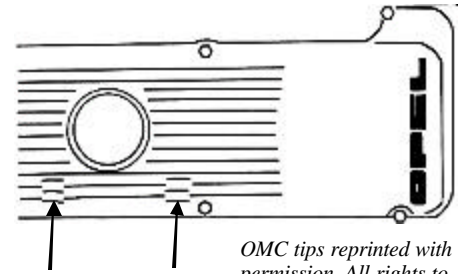

OMC tips reprinted with permission. All rights to images/text are reserved.

Thicker Hose

This (~15/32” ID, ~3/4” OD) hose connects to an inlet on the air filter system

The inlet location varies with the style of air filter system installed on an Opel.

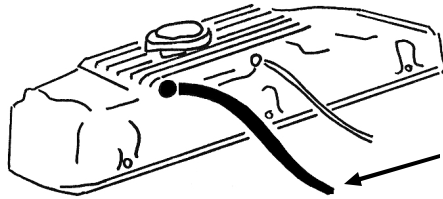

Original “Solex” Style Filter

On original air filter systems (or with adaptors to the Weber carb), this is a formed hose that connects to the metal “cap” that sits on top of the carburetor.

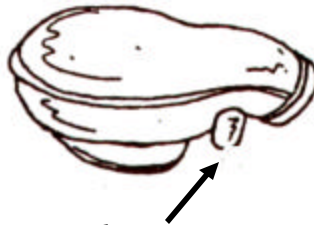

Hose connects here

“Weber Carb” Style Filter

On the basic Weber air filter, this a short length of a thick flexible hose connects to a plastic “elbow”.

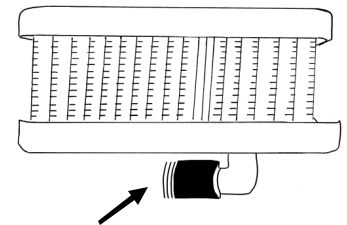

Hose connects here

Thinner Hose

This (~7/32” ID, ~13/32” OD) hose connects to a thin vacuum port on intake manifold.

This port was located in two different places on Opel manifolds.

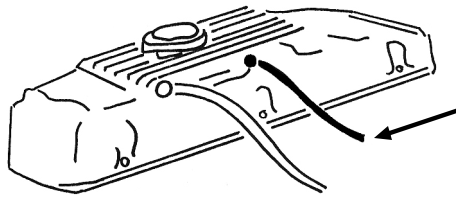

1968-1972 Manifolds

On 1968-1972 manifolds, the thinner hose connects to a port located below a thick brake booster hose.

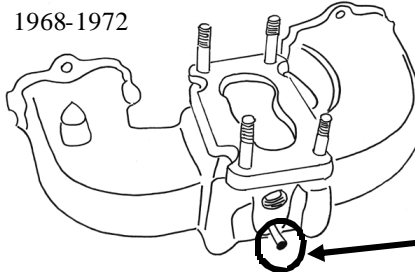

1968-1972

1973-1974 Manifolds

On 1973-1974 manifolds, the thinner hose connects to a port located on the side side of the manifold.

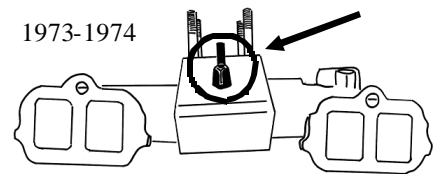

1973-1974

Manifold Vacuum Retard Port

1973-1974 EGR Valves

A port for the “EGR” (emissions-control) valve, was threaded below the main side fitting.

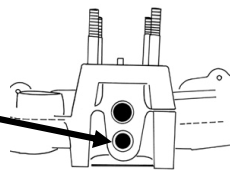

To accommodate this, the smaller port fitting, was relocated to the side facing the engine.

Opelclub.com 9/2009

Hose to “extra” carb vacuum advance port (Port on Solex & Weber 32/36 series 33B1 carbs)

1973-1974

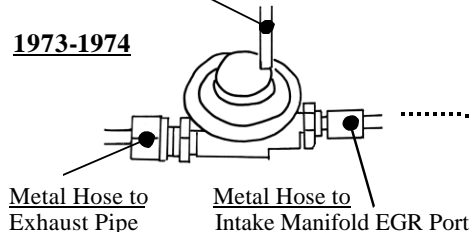

Metal Hose to Exhaust Pipe

Metal Hose to Intake Manifold EGR Port

At Right:

1974 “Dual” Style EGR valve (installed on vehicles originally sold in California)

1974 (Calif.-only)

