

Opel GT Headlight Notes

Perhaps the most unique parts of the Opel GT, are its patented "roll-over" headlights. It not only keeps the car looking good but also enhances the aerodynamics (when closed in daylight).

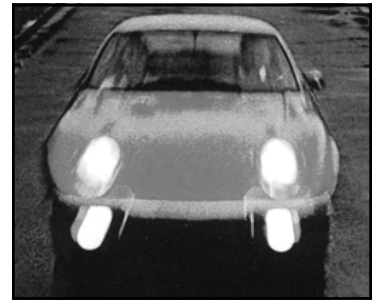

The headlights are adjusted by pushing the mechanical lever forward, which moves a cable that rotates front gear assemblies. Its circuitry is more complex, as "hidden" micro-switches (located on the rear side of the mechanisms) activate the main relay.

Opel GT Headlight-Related Parts

- 2024 Headlight Bucket Gasket
- 2033 Headlight Cable, New reproduction
- 5016 Hella H-4 Halogen Headlights, set of 2
- 5016A Halogen Headlamp Kit: Rounded face style, aftermarket
- 5049 Microswitch, for GT Headlight Mechanism:
Activates headlight relay to turn lights on/off. (3 per car)
- 5061 GT Replacement Headlight Relay:
Fits into existing GT headlight relay metal housing.
- 5069 Headlamp Adjuster Nut, threaded nylon, for GT
- 5077 Headlight Socket Plug (with 3 attached 10" long wires)
- 14001 Opel GT Electrical Schematics (Circuit Diagram copies)

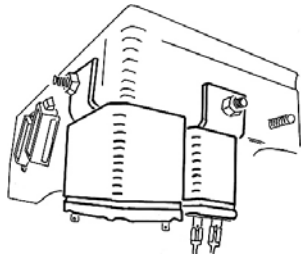
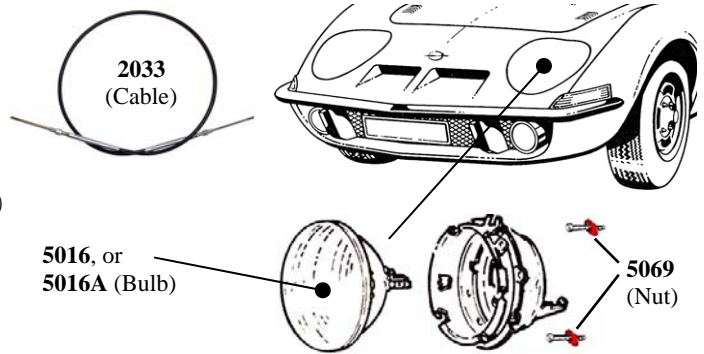

Circuit Relays are located at the rear of the fusebox.
5-wire = High-Beam
7-wire = Headlights (#5061)

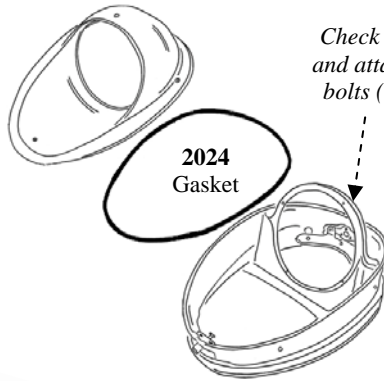

Check wires and attaching bolts ([here](#))



Recommended

For additional nighttime visibility and safety, we recommend upgrading from outdated sealed-beam to modern halogen headlight bulbs.

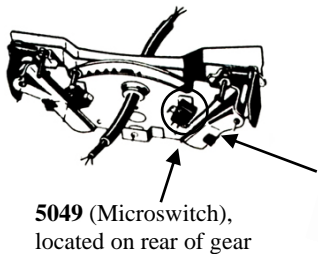

5049 (Microswitch), located on rear of gear

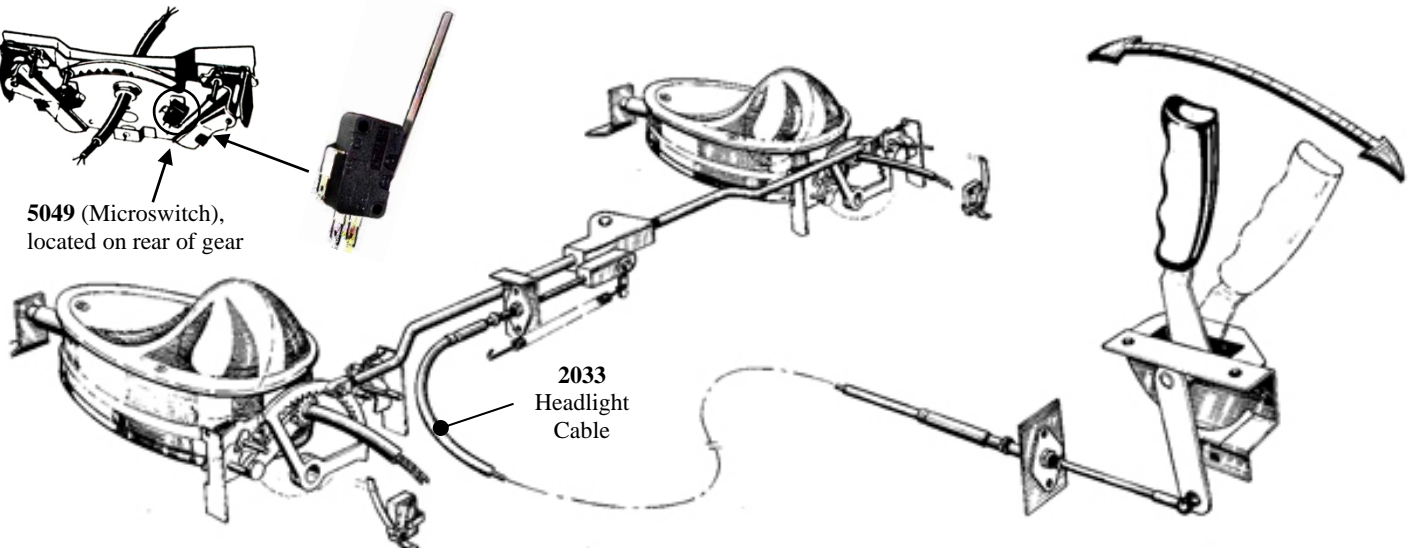

2033 Headlight Cable



Tech Tips: You MUST inspect the headlight wires (behind the headlight bulbs), as rubber insulation there is prone to cracking, and can cause a dangerous short-circuit. We recommend replacing with new wires (tech tip instructions are free online at www.opelclub.com). You can consider installing a fuse to this circuit for added safety. Also check under the headlight bucket lid for broken attaching bolts to the rotating gear mechanisms.

GT Headlight System Quick Diagnosis:

1) Verify GT Headlight Wires are fully functional (or replace, per tech article In following pages).

2) Verify GT Headlights are in the fully up position and both headlight buckets are latched. (or adjust, per Opel Service Manual or tech article in following pages).

3) To test, use DC voltmeter and insulated "jumper" cables on individual relay prongs.

****Perform these procedures with ignition key OFF when jumper wires are connected, then turn key on (without starting engine) for results****

4) Test Microswitch operation. Test for power at "A." If there is no power there, and microswitch is receiving power (from black wire at fusebox terminal #2, same circuit as high beam dash-panel indicator lamp), then microswitch is inoperative.

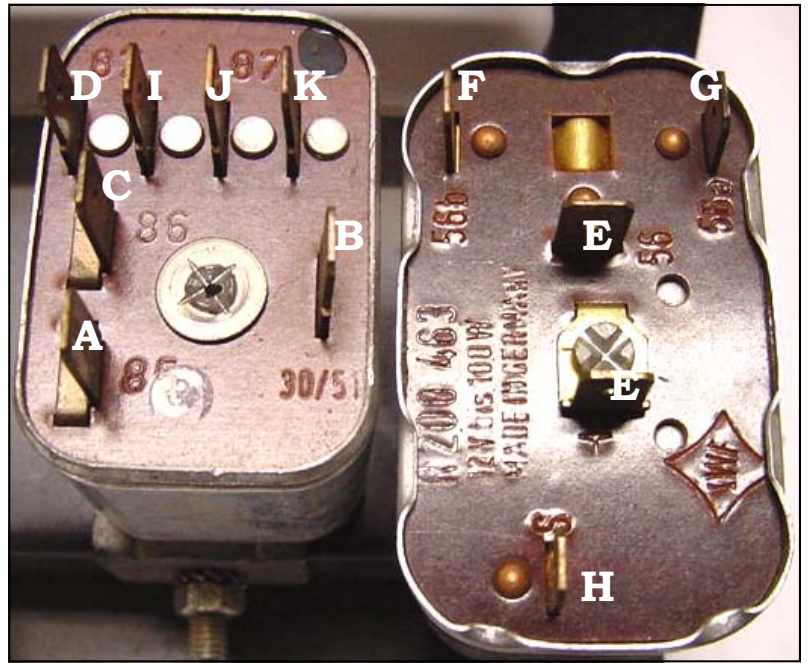

An alternative to the difficult job of pulling the driver's side headlight mechanism -- required to replace the micro-switch on 1970-1973 GT's -- is to add a substitute "toggle switch" to turn the headlights on and off. See Diagram, below right.

(Note: 1968-1969 GT's used a dual-microswitch circuit which operated in parallel, with an extra microswitch behind the passenger side headlight mechanism. Replacement microswitches are available from Opel retailers).

5) Test for 7-Prong Relay operation. Test for power at "A" "B" and verify ground connection at "C." If these are OK, but there is no power output at "D" then the relay is burnt internally and has failed. This is the main GT Headlight Relay, most commonly affected by short-circuits from cracked insulation on headlight wires. A replacement relay is available from Opel retailers.

6) Test for 5-Prong Relay operation. If there is power at "E" but there is no power at BOTH "F" and "G" (only one operates at a time), then the relay has failed. This is the "High Beam" relay.

7) Test Switch between High and Low Beam Circuit. Briefly touch "H" to ground. If output of 5-prong relay doesn't switch between low "F" and high "G" beams, then relay is bad. (This test can only be performed when "E" is receiving 12 volts from main 7-prong headlight relay).

Main 7-Prong GT Headlight Relay (terminal numbers in parentheses):

- A = Yellow/Black striped wire (85);
Carries switched power from microswitch output
- B = Red wire (30/51);
Carries unswitched power from battery via fusebox terminal
- C = Brown wire (86); Ground
- D = White/Yellow striped wire (87); This wire "splits" into two wires which
Carry 7-prong relay output power to 5-prong relay inputs labeled "E"
- I = Green/Black striped wire (87); Power to Left Side marker lights
- J = Gray/Red striped wire (87); Power to Right Side marker lights
- K = Gray/Green striped wire (87); Power to License Plate & Dash Lights

High-Beam 5-Prong GT Headlight Relay (terminal numbers in parentheses):

- E = White/Yellow striped wires (56);
Both tabs accept power input from 7-prong relay "D" output
- F = Yellow wire (56b); Low Beam Headlight Output
- G = White wire (56a); High Beam Headlight Output
- H = Green wire (S); Switch Circuit
(operated by the turn signal stalk in steering column)

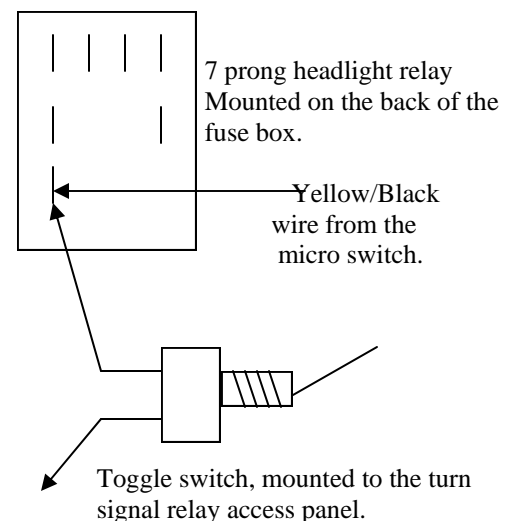

To the fuse box, #2 fuse
Add to the black wire connection.

Exterior Hardware Notes: Headlights

Headlights are the most unique and tricky, features on the Opel GT. They can be a heart-breaker, if they are not re-installed correctly — so installation instructions are noted here in more detail. (You should also refer to instructions found in the service manuals).

An important decision, is whether you will keep the headlight buckets on the car during the paint job. This is best advised if the car is repainted with the same color (the lid can easily be removed and painted separately, and the closed bucket can be lightly re-painted on the car. Ask your painter to avoid leaving paint drips on the sides). One downside to this approach, is possible micro-switch failure (caused by migrating paint and/or dust), which would require post-paint removal of headlight mechanisms anyways.

If the new paint is a color change, then you may prefer to remove the headlight buckets and paint them off the car (otherwise, the “old” color will contrast on the sides of the buckets). Paint them at the same time as the rest of the car, because temperature and drying conditions should be the same (otherwise they may dry a different shade, especially if “metallic” or cheap water-based paint is used).

When possible, re-install the headlights and hardware after paint has had a minimum of 30 days to harden or cure. This is also easier if done before re-installing a master cylinder or engine/transmission.

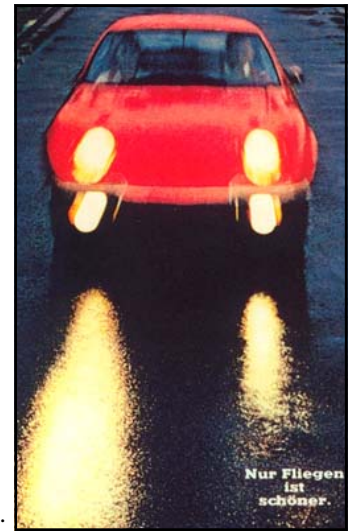

Disassembly:

GT headlight parts are side-specific, so as you remove them, identify and keep separate, the buckets, lids and mechanisms are for the driver's from the passenger side of the car. Place hardware in baggies with identifying notes.

Rotate buckets up. Work on one side at a time, as some parts (like the lids) are side-specific with different angles (that you don't want to mix up). Remove the lid on one side. Remove the headlight bulb (it's easiest by just removing it with the metal backing plate). Detach the headlight wires from the connector (Original Opel GT plastic connectors allow you to do this by either pressing on the spring, or by depressing a small tang), but some aftermarket styles may require you to cut the wires. Unbolt the 2 side 10mm bolts to the front pivot point, then remove the pivot bracket.

Remove the (3) 10mm head bolts on the center bracket and then carefully remove the (3) 8mm head bolts to the headlight mechanism.

Remove the center bracket, then apply tape around the bucket area, then rotate the bucket about 90 degrees and remove the bucket from the body. Either remove or mask off the headlight mechanisms.

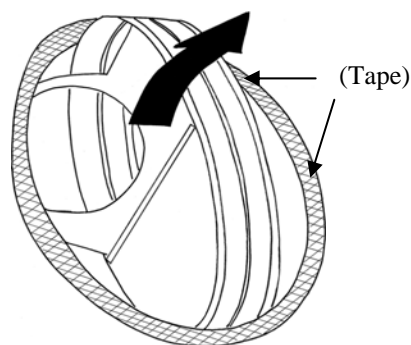

Headlight Bucket Removal

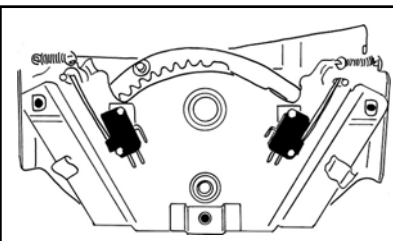
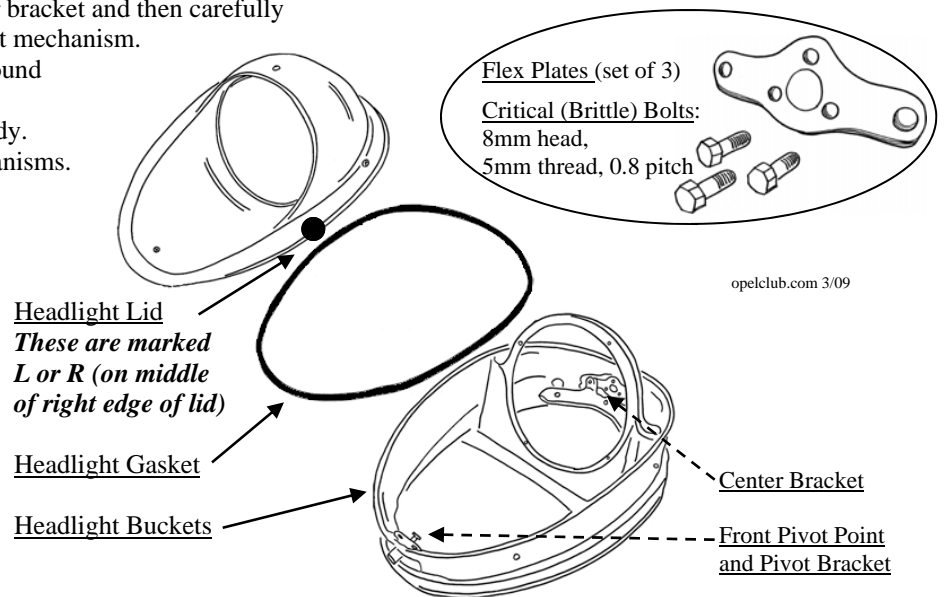

Driver's Side Headlight Mechanism (Above: Wire color connections)

Rear View: Note the 3 mount holes, and that its “peak” is on the right. The switch shown on the right activates the main headlight relay, and the switch shown on the left activates the white dashboard indicator light.

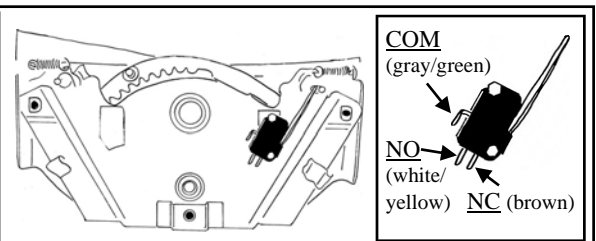
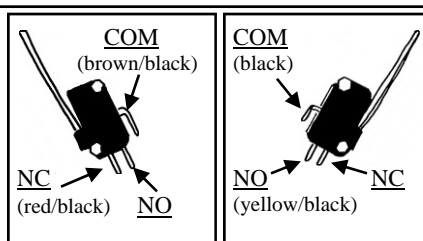

Passenger Side Headlight Mechanism

Rear View: Note that its “peak” is on the left. The switch activates the white dashboard light. (Note: 1969 GT's had a 2nd relay switch here, with same connections as left switch on driver's side)

Preparation:

To make opening and closing of the headlights easier, you should thoroughly clean the headlight mechanisms. Years of buildup of grease and dirt can be loosened, by first removing the micro-switches then soaking the mechanisms overnight in diesel fuel or solvent. Then use a flat-tip plastic knife blade, to scrape off residual grit from the gear surfaces. (Some even drill out the 4 crimps for more access to inner parts, then drill and tap holes to screw the mechanism back together). Re-lubricate with a thin coat of white lithium grease on the gear teeth. Use a tap, to clean the screw threads in the headlight mechanisms. Also check operation of micro-switches before reassembly.

Also check condition of 8mm bolts (they can shear off) and the 3 flex plates (they can crack). Clean and grease the inner threads and outer surface of the pivot points.

If headlight buckets are removed and painted separately, first replace headlight wires (if they haven't already - instructions are online at www.opelclub.com).

Installation:

Install adjustment rod with hood hinge in closed position, from driver's side bucket area to passenger side bucket area. Install headlight mechanisms, and snug the 3 10mm head bolts in place (from the inner fenderwell) and the one 10mm head bolt (in the driver's side hood compartment area) but don't tighten. Attach the adjustment rod to the mechanisms, and carefully install the small "spring clip" retainers (onto the groove in the pin).

An important step, is to protect the newly-painted round edge on the body around the headlight bucket, so that it doesn't scratch or chip (when the headlight buckets are installed). What is suggested is placing special auto body masking tape (with a low strength of adhesive) around the edges of this opening. This is even more important, if the body was damaged and repaired in this area (original clearances here were very tight, and damage increases the need to prevent interference when a headlight bucket is rotated). Clean off any residual paint dust in the bucket area.

You can also place a thin towel in the opening (to protect the bucket). The headlight bucket is installed sideways (as shown in the diagram), then rotated into position where the bulb is up (once it's in the body).

Attach the bucket to the headlight mechanism, by routing the 10mm head bolts and nuts between the connector bracket and the flex plates, then screwing in the three 8mm head bolts into the mechanism. Also loosely attach connector brackets to the front pivot point. Then check the fit of the bucket compared to the hole in the body. Adjustment front to back, is done with the center bolt on the front pivot. Adjustment side to side, and up and down, can be done by relocating the headlight mechanism (grabbing it from the rear, from within the fenderwells). During this process, rotate the bucket slightly, to verify it has sufficient clearance from all body surfaces (remember, the lid will have to clear also).

Once you are satisfied with your measurements, snug the bolts into place. Be extremely careful that you do not overtighten (or "snap") any of the three 8mm head bolts into the headlight mechanism. These are easily overtightened, and are extremely difficult to remove from the mechanism once broken (typically requires a machine shop to repair).

Bulbs should be installed with their metal retainer rings (to avoid a need to re-adjust them).

To install lids, identify which side is correct. Lock the headlight buckets into the open position, set down a gasket, then lightly snug into place. Hold the lid down while screwing and tightening the 2 rear screws (to avoid chipping paint), then do the front screw. Slowly rotate the buckets, to assure sufficient clearance from all surfaces, (including vertical mount bolts of the front round lens housings), when they will be turned while driving.

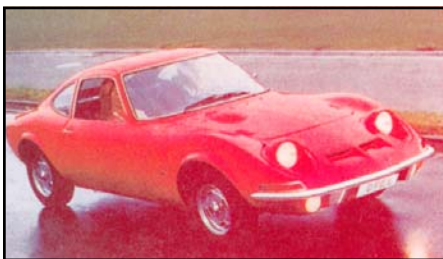

If necessary, install headlight cable. Note it can be adjusted near each end, and where it attaches to the adjustment rod. (This is better shown on the next page). The cable can be lubricated with a spray, like WD40 too.

The moment of truth, is the first time you push the headlight lever all the way with force, hoping they will turn and latch themselves completely into the open position (without any interference)

Headlight Bulb Hardware

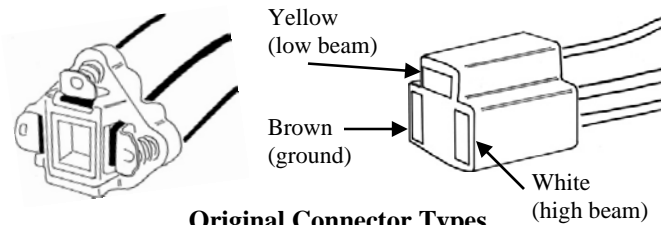

Original Connector Types

"Early" triangular style: Press springs to remove wires
"Later" slotted style: Depress inner tang, to remove wires

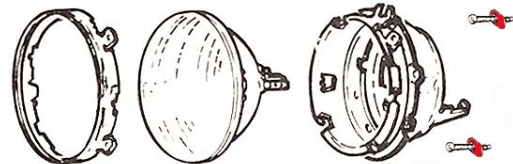

Bulb: It's easiest to remove bulb with the backing plate (instead of trying to back out the adjustment screws)

Headlight Cable Installation

The Opel GT Headlight cable generally only requires minor lubrication (WD40 works well), unless the cable itself has become “frozen” from internal rust. If you want much easier headlight opening and closing, you can consider replacing your old original cable with a new replacement headlight cable. An illustrated part breakdown is presented here.

Cable Removal

- Remove retainer pin
- Remove metal block and 8mm locknut
- Remove outer (14mm) adjusting nut and pull cable through bearing
- Pull cable through front chassis support
- Raise car (high enough for you to get under the transmission) and secure it on jack stands
- Remove wire clip and unsnap ball seat at control lever
- Remove ball socket and nut
- Remove rear adjustment nut
- Remove cable from retainers

Cable Installation

- Thread cable through bearing and clip retainers
- Install adjusting lock nut approximately 1/2" on thread
- Install lock nut stud on end of cable
- Connect ball stud to control lever with clip
- Adjust lock nut under vehicle for maximum cable length
- Thread cable through proper openings in body and install 14mm adjusting nut, 8mm locknut, metal block and retainer pin.
- Adjust cable length for proper headlight operation.
- Headlamp operating lever should clear console slot in extreme forward and backward positions.
- Refer to service manuals, for headlight adjustment and locking.

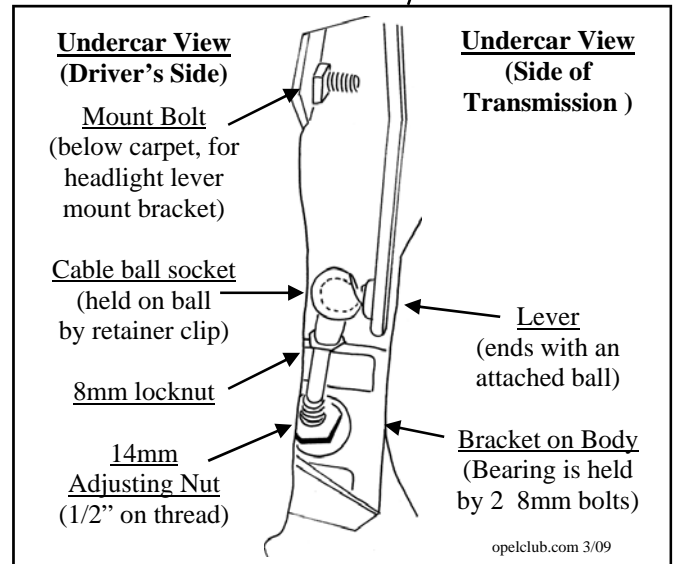
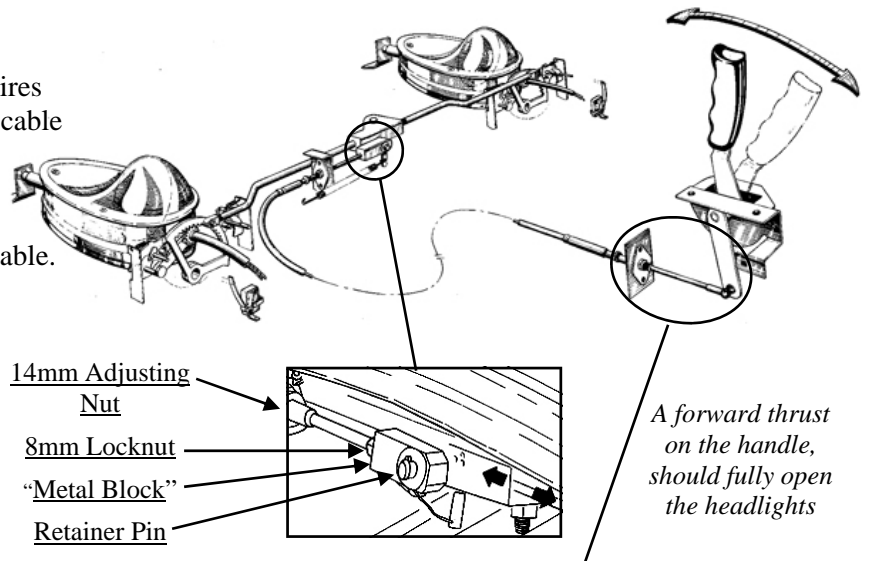

Headlight Adjustment Notes

Final adjustment should be done, after all other headlight components (including the headlight mechanisms, buckets and the headlight cable) have been installed.

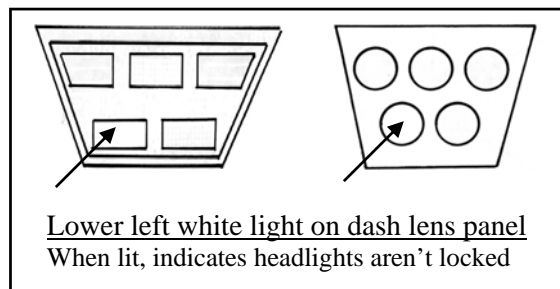

Handle Styles

Flat Plastic 1968-1969
Round Plastic 1970-1973 (held by small screw)

Headlight Lever

Bracket mounted under center (ashtray) console
Side bolt is under carpet

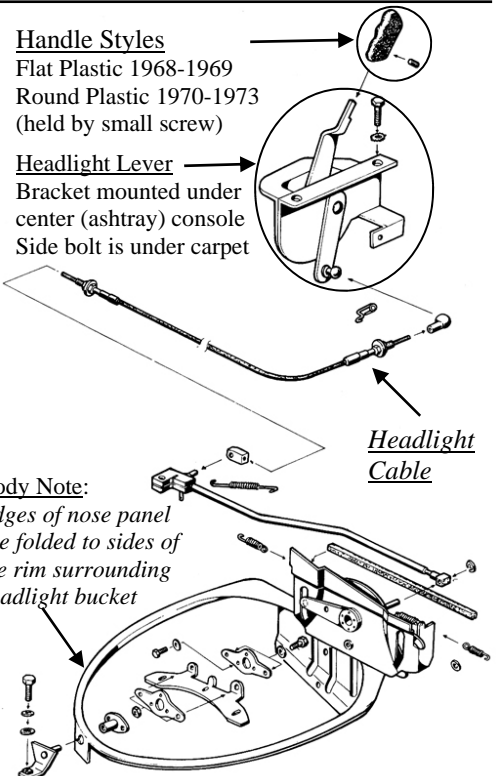

Headlights can be adjusted (relative to each other) by loosening a 13mm bolt on the center adjustment block, then aligning the closed headlight buckets to the body, then retightening the 13mm bolt.

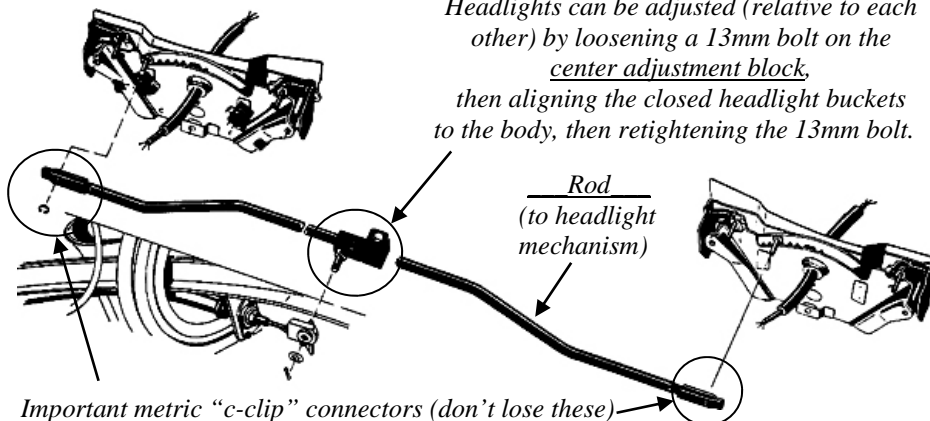

Opel GT Headlight Rewiring Tips:

ALL OPEL GT's NEED their headlights rewired!

The unique horizontal twisting and turning of GT headlights, after 30 years' time, cracks the old dried-out rubber insulation on the high current headlight wires, causing electrical shorts in the un-fused circuit, and has even caused fires in the engine compartment.

Because of these severe consequences, you need to perform this repair ASAP as a preventative measure !!

To visually inspect, turn ignition key off and open the headlights and unscrew 3 screws holding down metal headlight lid.

The area of most critical wear, is where the wire loom rotates behind the bulb; you can peel back some insulation here to view cracked rubber and bare wires. Additional symptoms may include: Failure of headlights, Failure of main (7-wire) headlight relay, and/or the amp gauge "pegging" when lights are switched on. (Refer to article for other GT headlight/micro-switch diagnoses).

****NOTE:** This procedure is for "driver" Opel GT's, as it leaves in place, some of the original circuit. If GT will be restored factory-original (or judged in a car show), either the original harness will have to be opened up and then re-taped, or completely replaced with an original-style replacement headlight wiring harness. Read all the notes, and have all parts ready, before starting.

Special Parts Required:

10 feet of 12-gauge wire: White, Yellow and Brown**
25 feet of Black Electrical Tape or Specialty Wire Wrap
2 Headlight Connectors, 3-Prong Type; Solder and Flux;
15 Black Wire Ties, Small Diameter; 2 Eyelet connectors
Flex Tubing, 15mm Outer Diameter, 2 pieces each 12" long
(Optional) Electrical Wire Sleeve (max 1/2" O.D.);
(Suggested) 2 Electrical Connectors, 3-Wire Detachable

Special Tools Required:

Wire Cutter, Solder Iron, Coat Hanger, Exact-o Knife

Procedure:

Disconnect battery cables. Open headlights and remove metal lids (See: "L" or "R" stamp on middle right lip of each lid; they are side-specific). Cut the wires to the 3-prong connector to the back of the headlight bulb.

Starting with the passenger "R" side: Inside front wheel-well, remove the 4 phillips-head screws holding the access plate (you have to scrape some undercoating off the heads of these 4 screws, to be able to turn them).

Prepare replacement wire loom. Cut 10' of each of the three wires into 2 lengths, 7 1/4 feet (87") for the passenger side, and 2 3/4 feet (33") for the driver's side. (Unless 1/2" O.D. electrical wire sleeve is used), tape a loom of three-color strands into a tight "triangle" at least 12" from one end, using overlapping, evenly spaced layers for clean look and protection.

This loom must fit through a narrow 15mm hole, So keep wires straight and tight in the new loom.

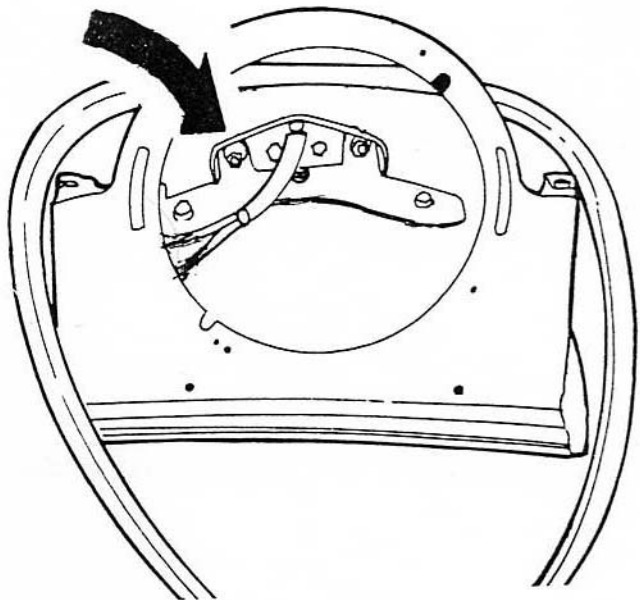

Where to look for frayed headlight wires

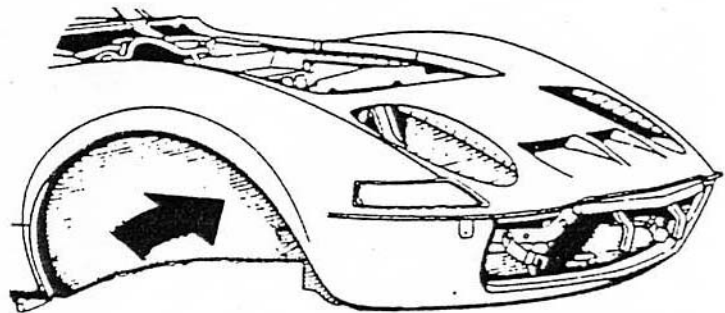

Where to locate access plate (passenger side shown)

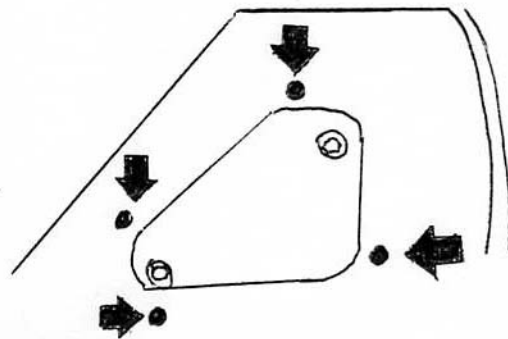

Access panel screw locations, Passenger side



Attach the end of this new 3-wire loom to the ends of the old wires by wrapping and taping them together, then from inside the wheel-well pull on the old wires, back from the bulb area back into the wheel-well. Push the end of a coat hanger from the engine area through the wiring grommet (in the front corner area) into the wheel-well area, then attach the end of the coat hanger to the 3-wire loom and securely tape together.

Carefully pull these wires back through the grommet into the under-hood area (It's a tight 15mm fit, so use some WD-40 or Vaseline to lube and protect the grommet and the tape on the new wire loom). Detach the ends of the new wires from the old wires, then cut into the old loom a couple of inches and cut off the old wires back in the old loom. Back at the headlight buckets, ensure that un-taped wire ends run through section of 15mm flex tubing in hole in headlight mechanism (to avoid chafing during rotation).

If a 3-wire detachable connector is used here (preferred, as it allows future removal without cutting wires), install it and solder or connect wires to the 3-prong type headlight bulb connector. Make sure wire colors are in correct location at headlamp bulb (see Diagram, at Right).



Passenger side headlight wiring and grommet entry to rear access panel area behind headlight mechanism

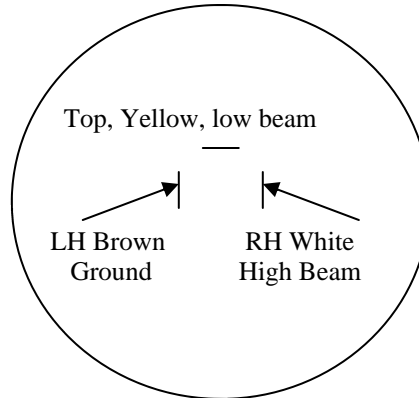

(Back side of headlight bulb)

Repeat wire replacement procedure on driver's side of car.

Then, for a clean look, use the black wire ties to neatly secure the new passenger-side loom to the old harness, where it goes in front of the radiator and back towards the master cylinder. You can also wire-tie the driver-side harness where it crosses under the master cylinder.

Separate brown (ground) wires from ends of the new wire looms near the Master Cylinder, then splice the yellow wire and the white wire to the existing wire harness. You have 2 options for location: The easiest to access, is on the main harness in the driver's side of the engine compartment, about 10" towards the rear from the radiator support beam. Unfurl the metal clips, then pull the main harness out from under the inner lip of the fender. The original splice location is near the master cylinder (where original wires connect 2-into-1 in the loom) but unless you insist on originality, it's a tight area for the splicing and soldering work.

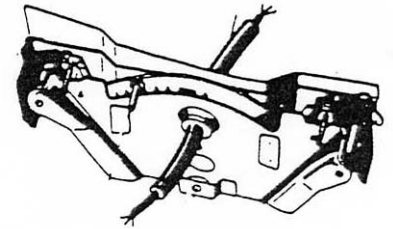

Wiring needs to pass through a flexible 15mm tubing to protect delicate insulation from rotating metal parts. As shown.

Open up the loom, by cutting sleeve lengthwise about 8" with an exact-o blade, then locate, tug out and cut the white wire and yellow wire (forward of area to be spliced). Prepare to splice the ends of the replacement white wires to a small section of the original white wire (use blade to strip a 1" area of insulation, or two separate 1/2" areas "staggered" for a cleaner look). Place some cardboard below the area for protection, then carefully solder (using lots of flux) these wires together. Let cool, then use this same approach but about 1" back, to solder the replacement yellow wires to the original yellow wire. Let cool, then tape up the loom, and hide the splice area by securing it with the clips under the inner lip of the fender.

Connect brown wires to chassis ground, by adding a round "eyelet" to wire ends and attaching with self-tapping screw to existing hole in engine area sheet metal (& sand off rust/paint there) on inner fender-well behind master cylinder (see photo).

Re-inspect all connections, to make sure they are secure and well insulated. Reinstall metal headlight lids. Reinstall 4-screw metal access plates in fender-wells. Reconnect battery cables. Test headlights for proper function.

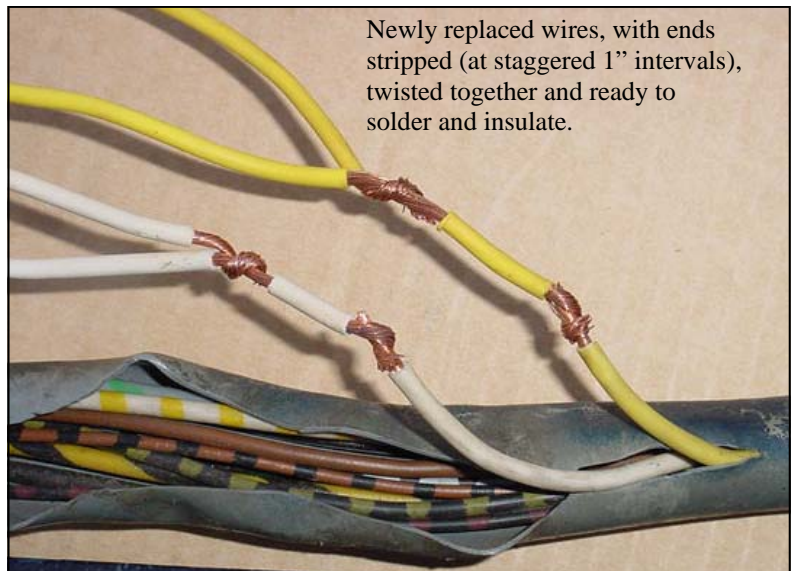

Newly replaced wires, with ends stripped (at staggered 1" intervals), twisted together and ready to solder and insulate.

GT Front Light & Horn Harness

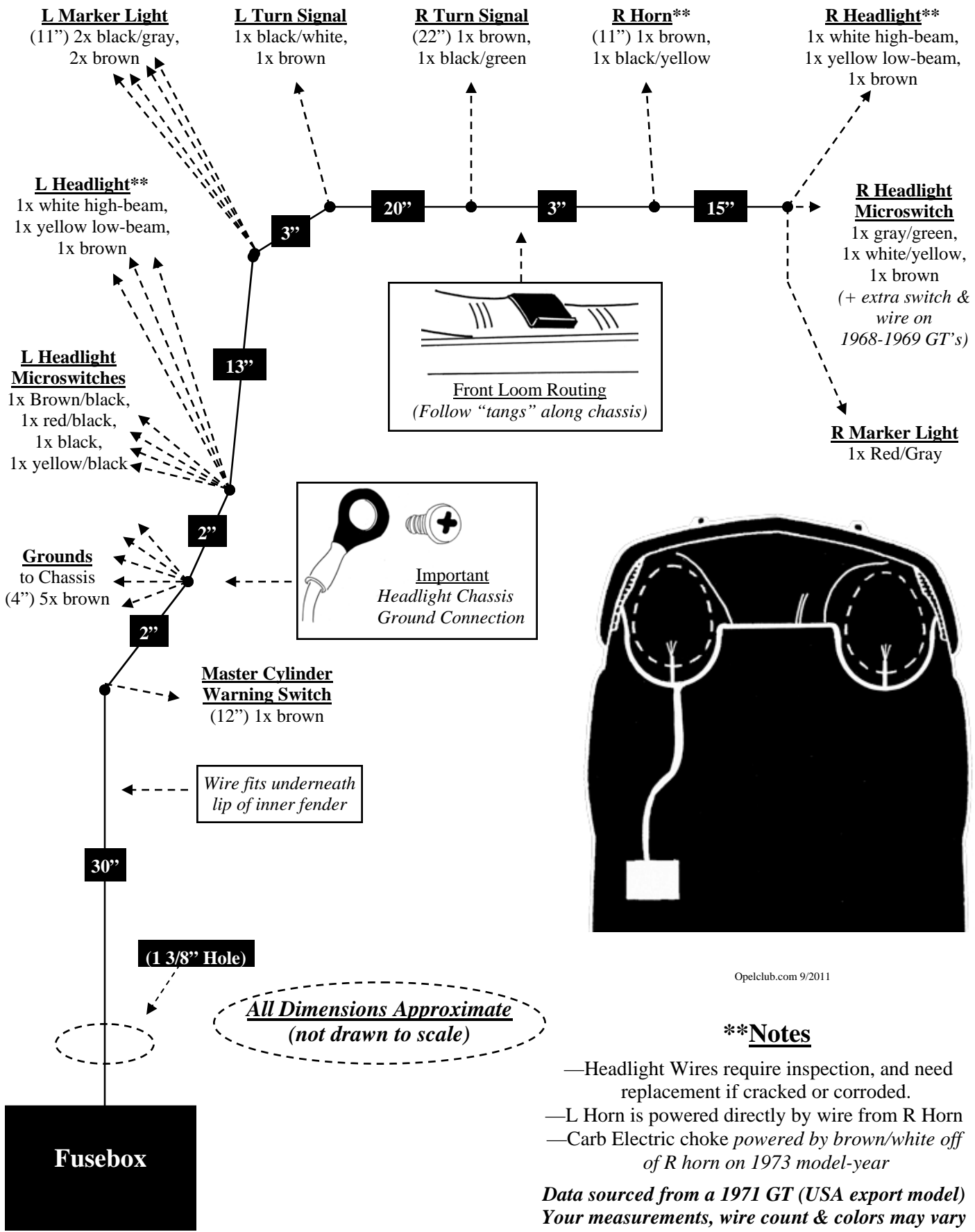

Opelclub.com 9/2011

**Notes

- Headlight Wires require inspection, and need replacement if cracked or corroded.
- L Horn is powered directly by wire from R Horn
- Carb Electric choke powered by brown/white off of R horn on 1973 model-year

Data sourced from a 1971 GT (USA export model)
Your measurements, wire count & colors may vary

Fusebox "Terminal Reference Guide"

Disclaimers:

The diagrams are based on a teardown of a 1971 GT.

These diagrams are for reference only— the actual wiring on your car may vary, based on its model year, installed options, and whatever a mechanic or prior owner may have altered.

We advocate confirming all wire applications using a continuity tester.

We do not accept responsibility for your actual results.

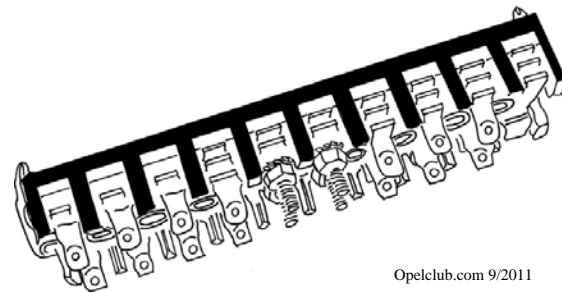

Opelclub.com 9/2011

*Always check front/rear and top/bottom orientation, by noting fuse terminal locations

High-Beam Relay
5-wire relay, controls switching of high-beams on headlights

Main Headlight Relay
7-wire relay, controls on/off switching of headlights

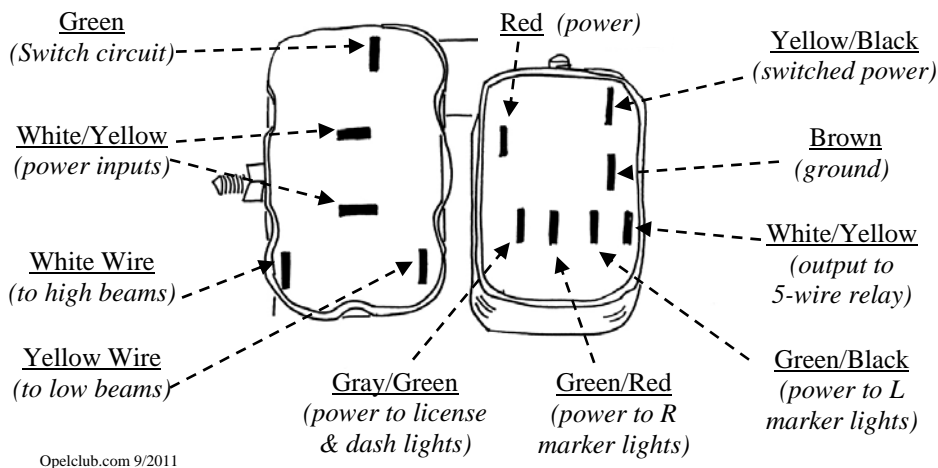

Information compiled in this guide is provided in part via permission from the Opel Motorsport Club

All rights to original text and images are reserved.

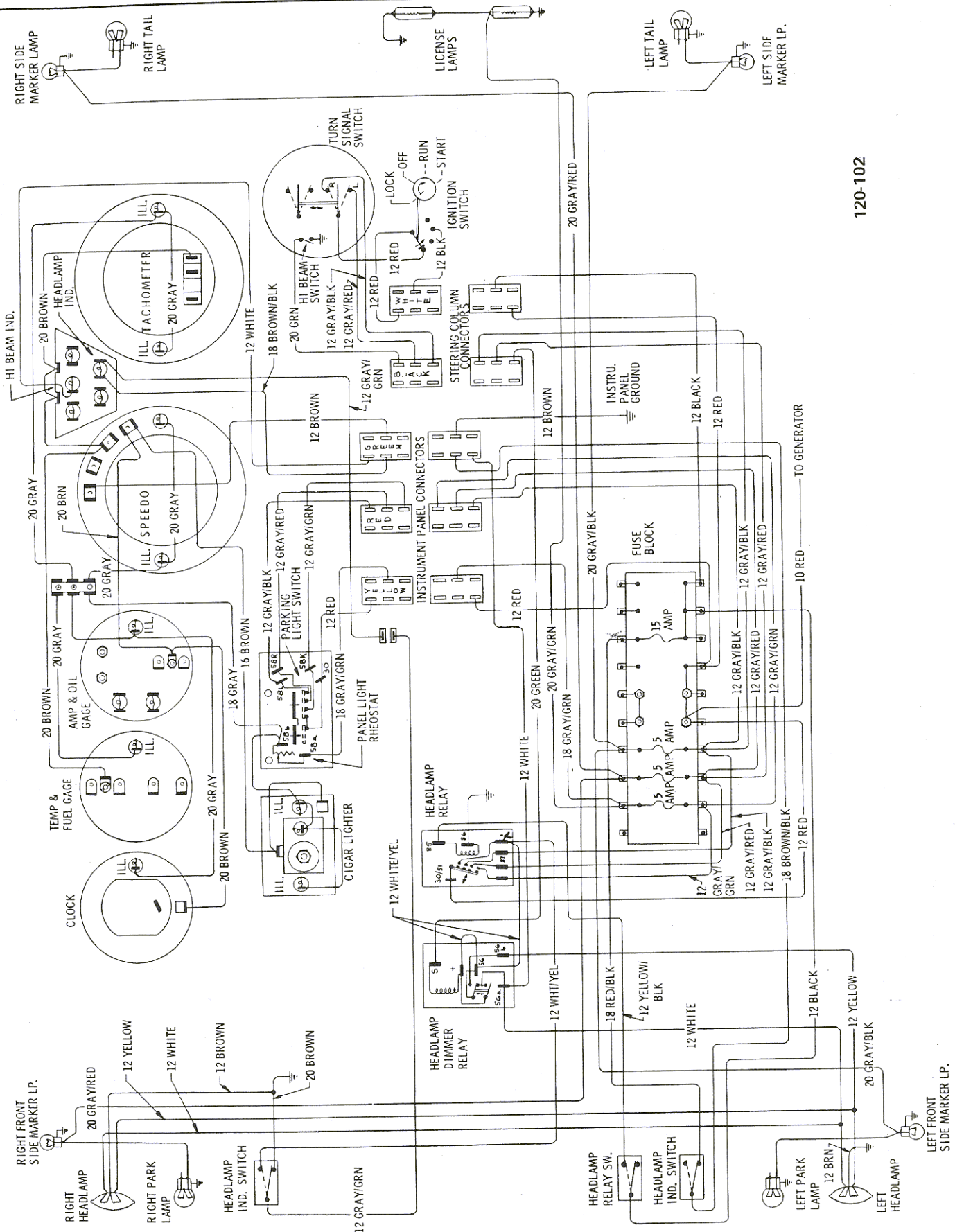

120-102

Figure 120-110 - Headlamp, Parking, Tail and Instrument Illumination - GT